

PP1 시리즈

Piggyback M5



PP1

표준 사양

사용유체	압축공기
최고사용압력	10bar (1.0MPa)
보증내압력	15bar (1.5MPa)
주위온도 및 사용유체온도	-5 ~ 60°C (동결없어야 함)
설정압력범위	0.5~8.5bar (0.05~0.85MPa)
여과도	10 μ m (옵션 : 2, 5, 20, 40)
바울재질	폴리카보네이트 (옵션 : ALDC)
구조	릴리프타입

표시기호

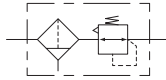

품번 체계

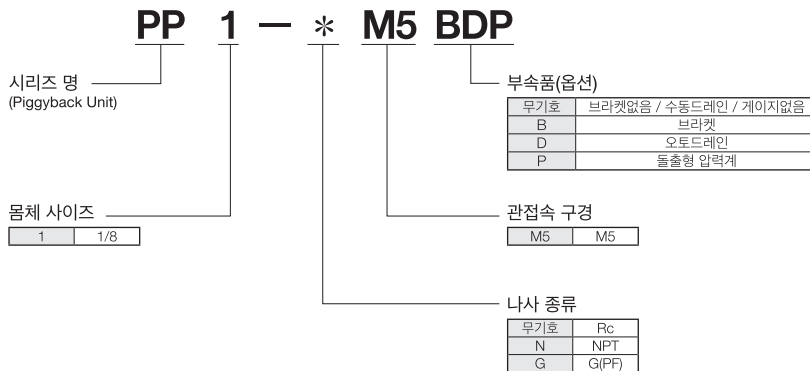

PC1

PF1

PR1

PL1

PP1

PC2

PF2

PR2

PL2

PP2

PC3

PF3

PR3

PL3

PP3

PC4

PF4

PR4

PL4

PP4

PC5

PF5

PR5

PL5

PP5

PC8~9

PF8~9

PR8~9

PP1 시리즈

구조도

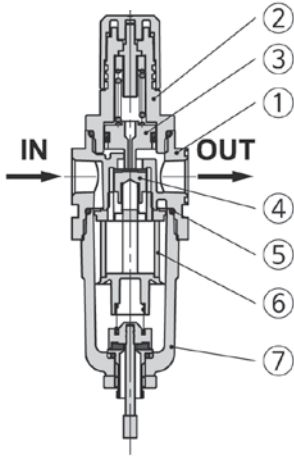

주요 부품 LIST

번호	부품명	재질
①	보디	아연 다이캐스팅
②	커버	N66G
③	피스톤	N66G
④	체크Ass'y	황동, NBR
⑦	바울 Ass'y	PC



예비부품 LIST

번호	부품명	재질	부품번호
			PP1
⑤	엘리먼트	NBR	S22
⑥	오링	-	W100-EL

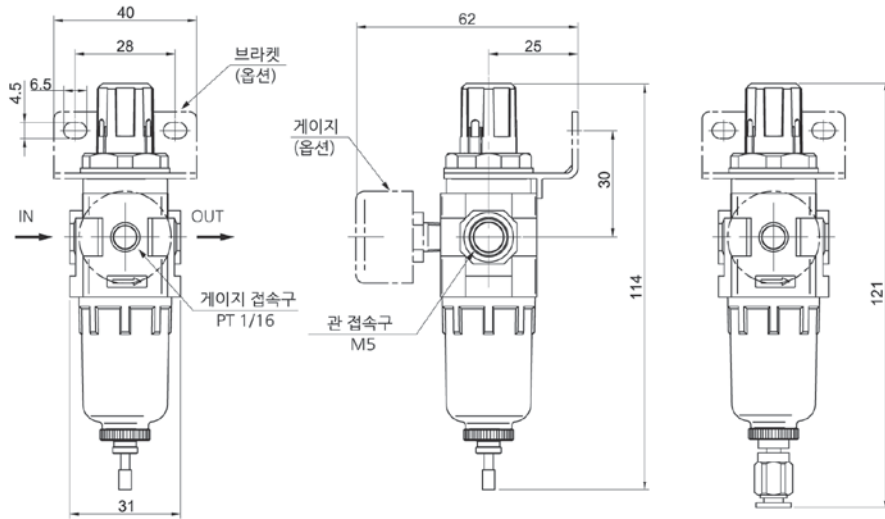
치수도

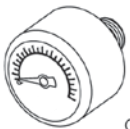

오토드레인(차압식) 부착시

옵션	P : 게이지	B : 브라켓	D : 오토드레인(차압식)
품명	 G25, R1/16	 B120	 Φ4mm 원터치휘팅