

PER1~2 시리즈

정밀 레귤레이터



- 정확한 압력조정
- 사용 안정성
- 유량 안정성
- 높은 자동하류 방출성능
- 온도의 안정성

표시 기호

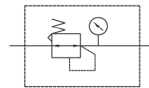

주문형식

PER 1 — N 01 B G — 2K

1 2 3 4 5 6 7

1 Precision Pressure Regulator

2 Body Size
1 : PER 1 (1/8)
2 : PER 2 (1/4)

3 Thread
Blank : Rc
N : NPT
G : G(PF)

4 Port Size
01 : 1/8(PER1)
02 : 1/4(PER2)

5 Bracket
B : Bracket

6 Pressure gauge
Blank : No gauge
G : Pressure gauge

7 Set Pressure Range
2K : 0.005~0.2 Mpa
4K : 0.01~0.4 Mpa
8K : 0.01~0.8 Mpa

브라켓 개별 주문품번

PER 1 — B

1 2 3

1 Precision Pressure Regulator

2 Body Size
1 : PER 1 (1/8)
2 : PER 2 (1/4)

3 Bracket

압력계 개별 주문품번

G33 — 2K

1 2

1 Diameter Size
G33 : Ø33
G42 : Ø42

2 Set Pressure Range
2K : 0.005~0.2MPa
4K : 0.01~0.4MPa
8K : 0.01~0.8MPa

PL8~9

PFH(U)2~
PFH(U)5

PPH(U)3~
PPH(U)4

TAMG

TAFL

TAM

TAMD

TAMH

TAMU

PLV

PSH

PCV

MB

PA

SSV

SMS1000

ACCESSORIES

PER1~2

PER3000

PVR3000
PNR4000

WR1

PRU

ABS

ABST

TXF
THF-H

TAD
THT

PER1~2 시리즈

표준사양

시리즈명	PER 1	PER 2
Port size	1/8	1/4
사용유체	Air	Air
최고사용압력	1 MPa	1 MPa
보증압력	1.5 MPa	1.5 MPa
조정압력범위	2K : 0.005~0.2 MPa	2K : 0.005~0.2 MPa
	4K : 0.01~0.4 MPa	4K : 0.01~0.4 MPa
	8K : 0.01~0.8 MPa	8K : 0.01~0.8 MPa
민감도	Within (E) 0.2% of full span	Within 0.2% of full span
반복도	Within (E) ±0.5% of full span	Within ±0.5% of full span
주위온도	-5~+60°C (No freezing)	-5~+60°C (No freezing)
부착방법	Bracket	Bracket
Option	Bracket, Pressure gauge (G33)	Bracket, Pressure gauge (G42)
무게	150g	300g

PER1 유량특성

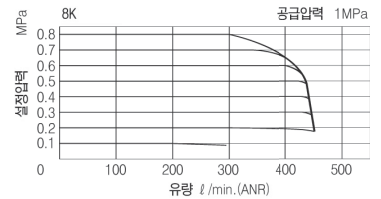
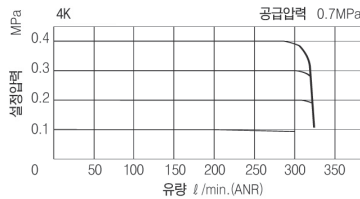
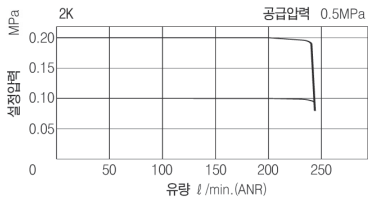

PER2 유량특성

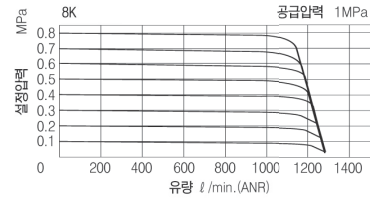
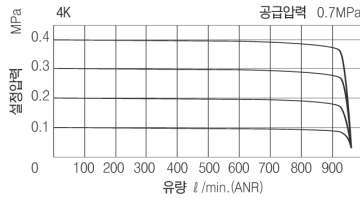
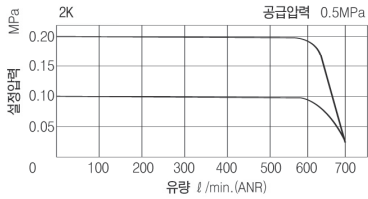

PER1 · 2 치수도

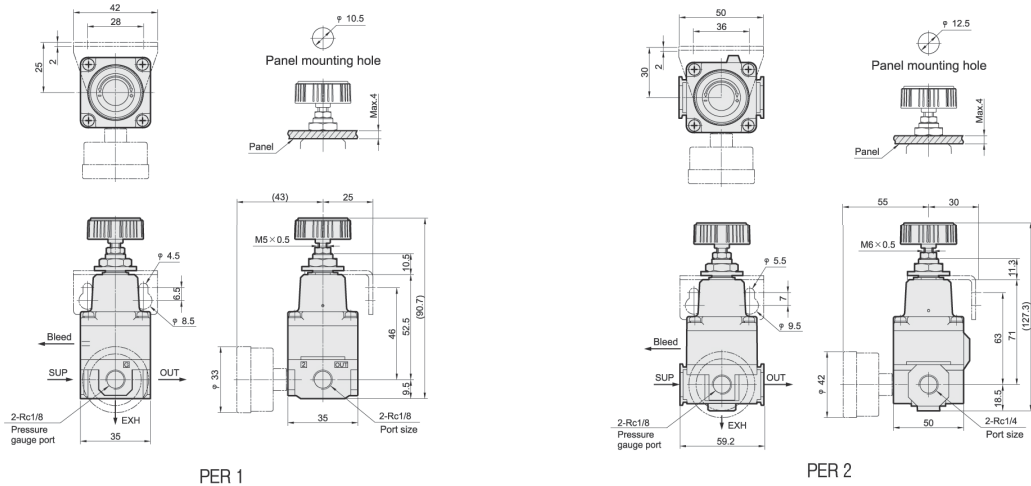

PER 1

PER 2