

DP300·3000·5000 시리즈

3.5포트 에어 파일럿 밸브

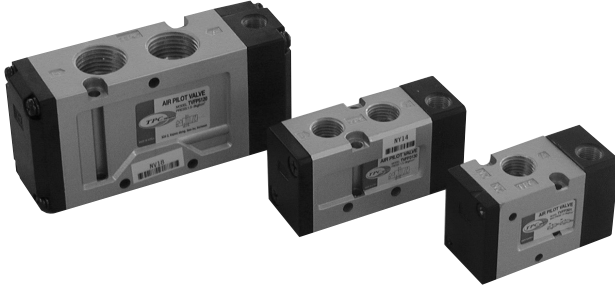

- 소형 · 경량
 - 폭 26.4 mm (DP300, DP 3000 시리즈)
 - 폭 32 mm (DP 5000 시리즈)
- 큰 밸브 용량
 - Cv 1.0 Rc(PT) 1/4 (DP300, DP 3000 시리즈)
 - Cv 3.2 Rc(PT) 1/2 (DP 5000 시리즈)

표시 기호

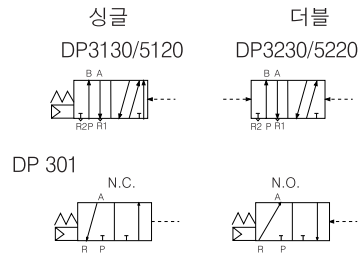

주문형식

DP3000시리즈

DP3

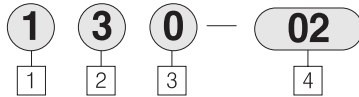

- 1 절환방식
1 : SINGLE PILOT TYPE
2 : DOUBLE PILOT TYPE
- 2 몸체 형식
3 : 직접 배관형
(3형 매니폴드용)
- 3 몸체 사양
0 : 표준형
- 4 관 접속구경 (P, A, B)
01 : Rc(PT) 1/8
02 : Rc(PT) 1/4
※배기포트 1/8

DP5000시리즈

DP5

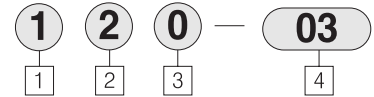

- 1 절환방식
1 : SINGLE PILOT TYPE
2 : DOUBLE PILOT TYPE
- 2 몸체형식
2 : 직접배관형
(2형 매니폴드용)
- 3 몸체사양
0 : 표준형
- 4 관 접속구경 (P, A, B)
03 : Rc(PT) 3/8
04 : Rc(PT) 1/2
※배기포트 1/8

DP300시리즈

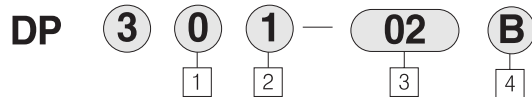

- 1 절환방식
0 : N · C/N · O공용
- 2 몸체 형식
1 : 직접 배관형
- 3 관 접속구경 (P, A)
01 : Rc(PT) 1/8
02 : Rc(PT) 1/4
※배기포트 1/8
- 4 절환방식
· A : N · C
· B : N · O

TV2

TV2WFI

TV2WC

FSW

DR100
DR200

RS1000
RS2000

RS4000
RS4R

SI UNIT

RDV100
RDV300
RDV400

DVC1000

DV1000
DV3000
DV4000

DVUM1000
DVUM3000
DVUM4000

DVP1000
DVP3000
DVP4000

RDS300
RDS3000
RDS5000

RDSN3000

DS2000
DS6000

DX1
DX2

DX1R
DX2R

TVH

TFVM

DP300
DP3000
DP5000

DM

DT220

DQE

DCV

TX350

DP300-3000-5000 시리즈

사양

사용 유체	압축 공기		
사용 압력 범위 MPa(kgf/cm ²)	2위치	SINGLE	0.15~0.9(1.5~9)
		DOUBLE	0.1~0.9(1~9)
주위 온도 및 사용 유체 온도 ℃	MAX. 60		
PILOT 압력범위 MPa(kgf/cm ²)	2위치	SINGLE	^(주 2) 0.16~0.9(1.7~9)
		DOUBLE	0.1 ~ 0.9(1~9)
급 유	필요 없음(급유의 경우 터빈유 1종, ISO VG32)		
내충격/내진동 m/s ²	300 / 50 (8.3 ~ 2000 Hz)		
부착 자세	자 유		
(주 1) 유효단면적 mm ² (Cv 치)	Rc(PT)1/8	14(0.8)	
	Rc(PT)1/4	17.5(1.0)	
	Rc(PT)3/8	48(2.7)	
	Rc(PT)1/2	56(3.1)	
PILOT 접속구경	Rc(PT)1/8 공용		

(주 1) 밸브 자체의 유효 단면적

(주 2) PILOT 최저압력은 $(0.5 \times P + 1) \{0.5 \times P + 0.1\}$ 보다 높게 할것(P:공급압력)

형식

배관방식	형 식	변 환 방 식	관 접속구경	유효단면적 mm ² (Cv 치)	
직접배관식	DP3130	2위치 SINGLE	Rc(PT)1/8	Rc(PT)1/8	Rc(PT)1/4
			Rc(PT)1/4	14(0.8)	18(1.0)
	DP3230	2위치 DOUBLE	Rc(PT)1/8	14(0.8)	18(1.0)
			Rc(PT)1/4	14(0.8)	18(1.0)
DP5120	2위치 SINGLE	Rc(PT)3/8	Rc(PT)3/8	Rc(PT)1/2	
		Rc(PT)1/2	48(2.8)	58(3.2)	
DP5220	2위치 DOUBLE	Rc(PT)3/8	48(2.8)	58(3.2)	
		Rc(PT)1/2	48(2.8)	56(3.2)	

직접배관형/2위치 3포트

DP301

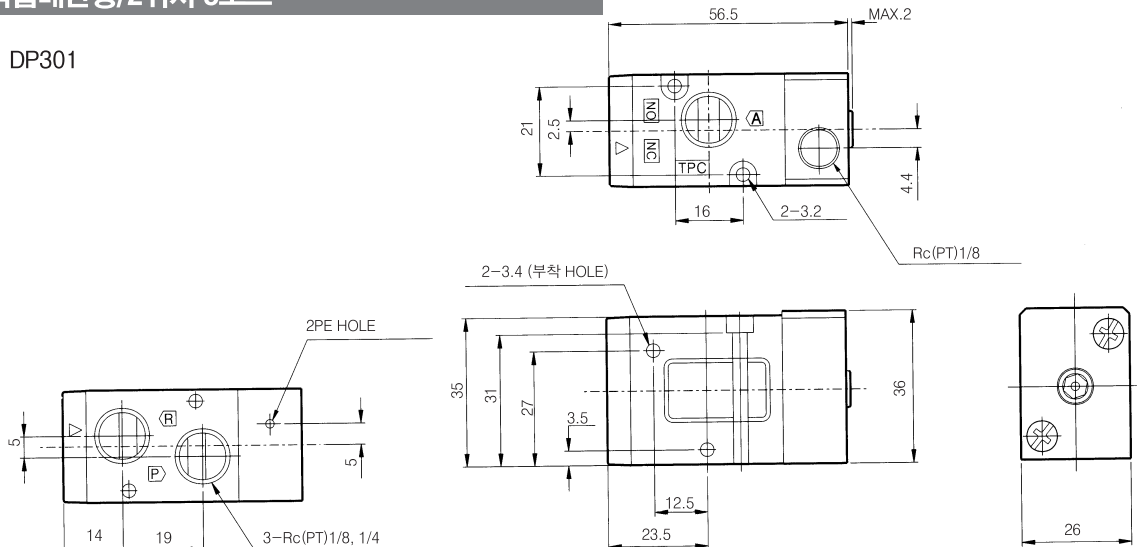

3.5포트 에어 파일럿 밸브 DP300-3000-5000 시리즈

직접배관형/2위치 SINGLE, DOUBLE

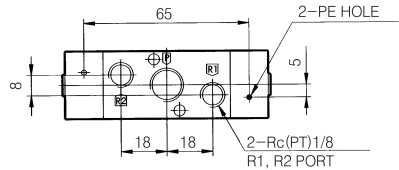
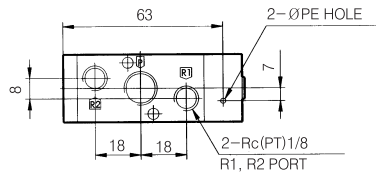
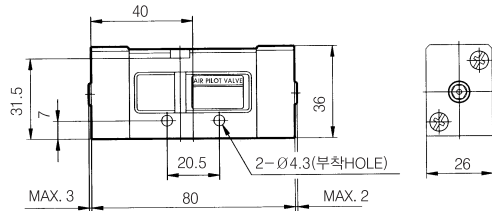
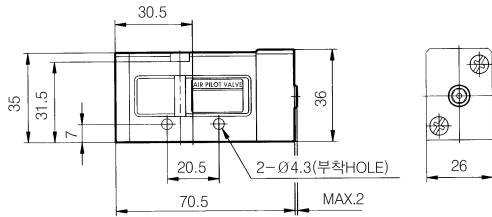
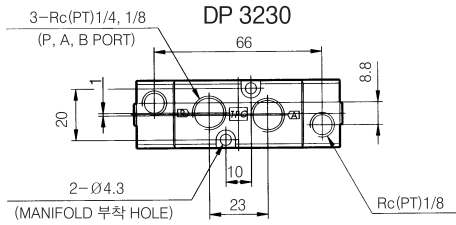
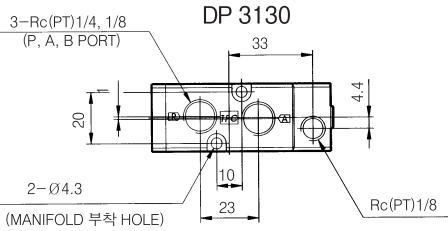

직접배관형/2위치 SINGLE, DOUBLE

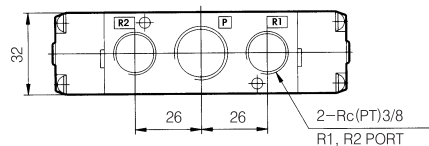
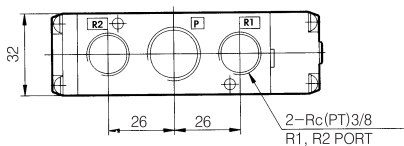
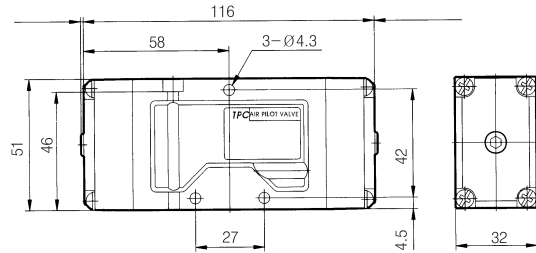
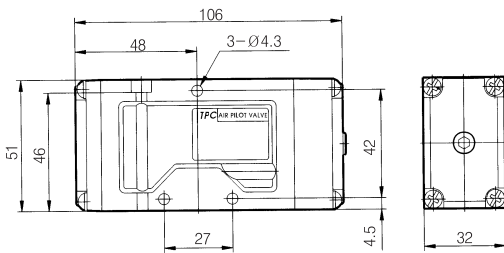
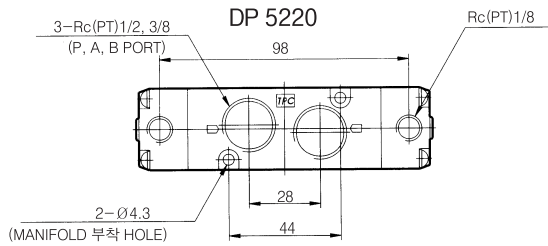
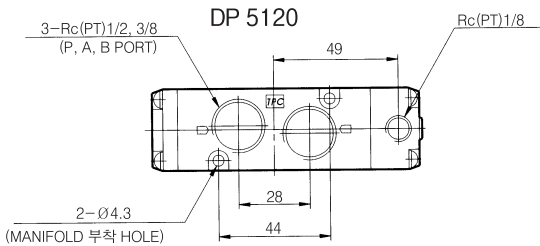

TV2

TV2WFI

TV2WC

FSW

DR100
DR200

RS1000
RS2000

RS4000
RS4R

SI UNIT

RDV100
RDV300
RDV400

DVC1000

DV1000
DV3000
DV4000

DVUM1000
DVUM3000
DVUM4000

DVP1000
DVP3000
DVP4000

RDS300
RDS3000
RDS5000

RDSN3000

DS2000
DS6000

DX1
DX2

DX1R
DX2R

TVH

TFVM

DP300
DP3000
DP5000

DM

DT220

DQE

DCV

TX350